



**LAZIO DOCCIA**

**PROFILE ALUMINIOWE DO KONSTRUKCJI  
KABIN PRYSZNICOWYCH**  
ALUMINIUM PROFILES FOR THE CONSTRUCTION  
OF THE SHOWER ENCLOSURES

**CDA**

# LAZIO DOCCIA

## PROFILE ALUMINIOWE DO KONSTRUKCJI KABIN PRYSZNICOWYCH ALUMINIUM PROFILES FOR THE CONSTRUCTION OF THE SHOWER ENCLOSURES



### PORÓWNANIE WYMIARÓW RÓŻNYCH PROFILI

COMPARING THE DIMENSIONS OF THE DIFFERENT PROFILES

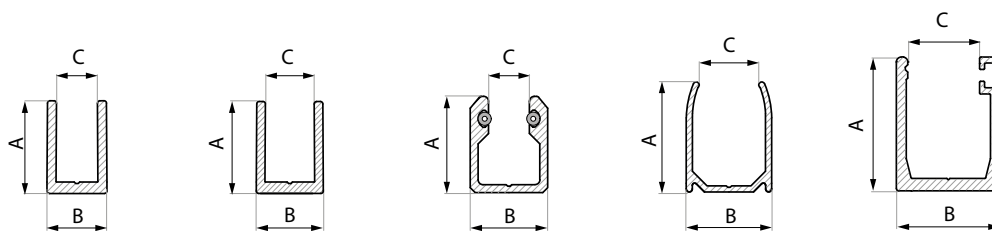

Wykończenie / Finish	FIXSG08	FIXSG10	FIXS	FIXD	FCM27U
[A] wysokość height	18.5	18.5	19.5	22.5	27
[B] szerokość width	12	14	15.7	17.5	21
[C] szerokość wew. inside width	8.2	10.2	8	12.2	14.5

## FIXSG08

Profil do montażu panelu stałego  
U-section profile for fixed panels

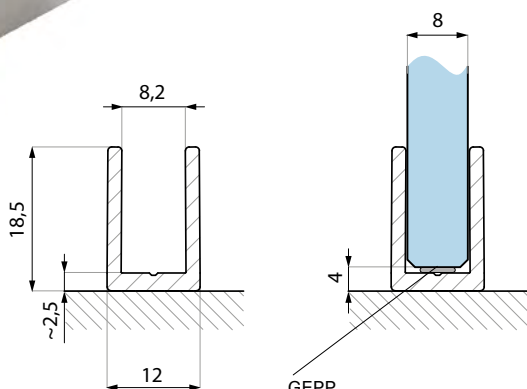

GEPP  
Profil ochronny na krawędź szkła  
(nie dołączony do profilu)  
Glass edge protection /  
(not included with the profile)

stal nierdzewna  
stainless steel

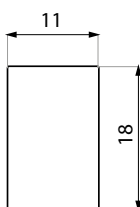

Kod / Code	Wykończenie / Finish
<b>FIXSG08-2300PC</b> <b>FIXSG08-3000PC</b> <b>FIXSG08-4000PC</b>	połysk polished
<b>FIXSG08-2300AX</b> <b>FIXSG08-3000AX</b>	alinox alinox
<b>FIXSG08-2300NABL</b> <b>FIXSG08-3000NABL</b>	czarna anoda black anodised
<b>FIXSG08-3000 PBC</b>	złoty gold

### Specyfikacja / Specification

materiał: material:	aluminium aluminium
grubość szkła (mm): glass thickness (mm):	8
długość (mm): length (mm):	połysk / polished finish: 2300; 3000; 4000 alinox / alinox finish: 2300; 3000 czarna anoda / black anodised finish: 2300; 3000

montaż do szkła za pomocą taśmy dwustronnej, kleju lub silikonu (nie dołączone do produktu)  
glass installation using double-sided tape, glue or silicone (not included with the product)

Zaślepka  
End cap

**FIXSG08-EC**

Kod / Code	Wykończenie Finish	Materiał Material
<b>FIXSG08-EC PSS</b>	połysk polished	stal nierdzewna stainless steel
<b>FIXSG08-EC SSS</b>	satyna satin	stal nierdzewna stainless steel
<b>FIXSG08-EC ABS BL</b>	czarna black	ABS ABS
<b>FIXSG08-EC PBC</b>	złota gold	stal nierdzewna stainless steel

## FIXSG10

Profil do montażu panelu stałego  
U-section profile for fixed panels

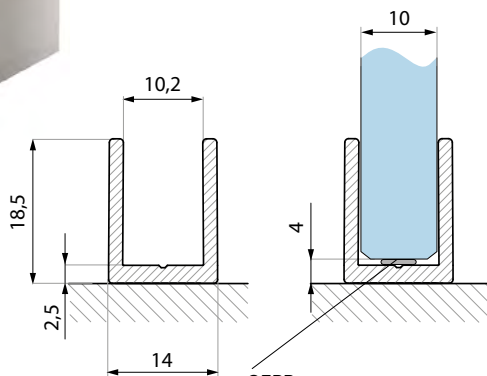

GEPP  
Profil ochronny na krawędź szkła  
(nie dołączony do profilu)  
Glass edge protection /  
(not included with the profile)

stal nierdzewna  
stainless steel

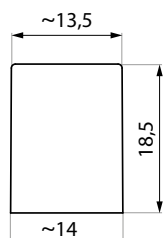

Kod / Code	Wykończenie / Finish
<b>FIXSG10-2300PC</b> <b>FIXSG10-3000PC</b>	połysk polished
<b>FIXSG10-2300AX</b> <b>FIXSG10-3000AX</b>	alinox alinox
<b>FIXSG10-2300NABL</b> <b>FIXSG10-3000NABL</b>	czarna anoda black anodised

### Specyfikacja / Specification

materiał: material:	aluminium aluminium
grubość szkła (mm): glass thickness (mm):	10
długość (mm): length (mm):	połysk / polished finish: 2300; 3000; alinox / alinox finish: 2300; 3000 czarna anoda / black anodised finish: 2300; 3000

montaż do szkła za pomocą taśmy dwustronnej, kleju lub silikonu (nie dołączone do produktu)  
glass installation using double-sided tape, glue or silicone (not included with the product)

Zaślepka  
End cap

**FIXSG10-EC**

Kod / Code	Wykończenie / Finish	Materiał / Material
<b>FIXSG10-EC PSS</b>	połysk polished	stal nierdzewna stainless steel
<b>FIXSG10-EC SSS</b>	satyna satin	stal nierdzewna stainless steel
<b>FIXSG10-EC ABS BL</b>	czarna black	ABS ABS

# FIXS

Profil do montażu panelu stałego z zamontowanymi uszczelkami  
U-section profile for fixed panels with preassembled seal

Kod / Code	Wykończenie / Finish
<b>FIXS-SET2300 PC</b> <b>FIXS-SET3000 PC</b>	potysk polished
<b>FIXS-SET2300 AX</b> <b>FIXS-SET3000 AX</b>	alinox alinox
<b>FIXS-SET2300 NABL</b> <b>FIXS-SET3000 NABL</b>	czarna anoda black anodised
<b>FIXS-SET2300 PGC</b>	imitacja złoty similar gold

### Specyfikacja / Specification

materiał: material:	aluminium aluminium
grubość szkła (mm): glass thickness (mm):	8
długość (mm): length (mm):	potysk / polished finish: 2300; 3000 alinox / alinox finish: 2300; 3000 czarna anoda / black anodised finish: 2300; 3000 imitacja złoty / similar gold: 2300
zawiera uszczelki seals included	

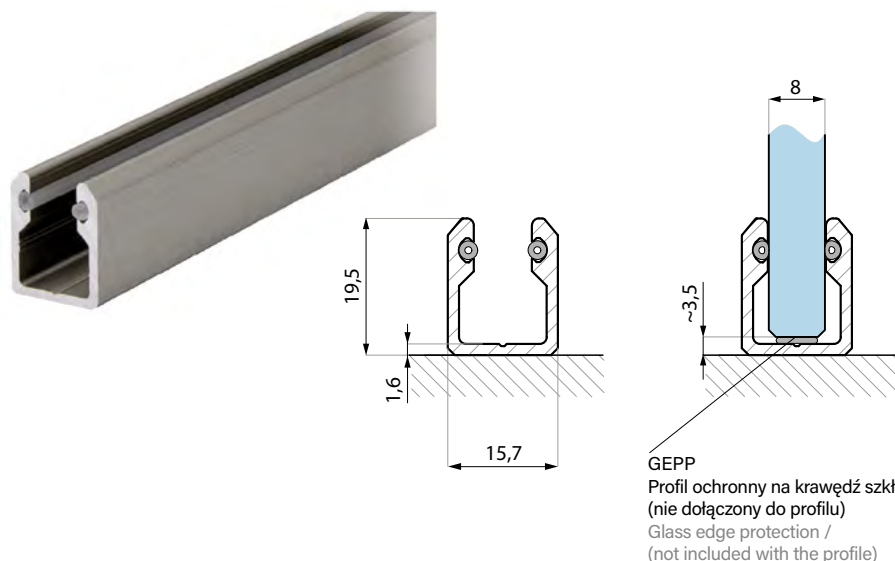

Zaślepka  
End cap

## FIXS-EC



Kod / Code	Wykończenie / Finish	Materiał / Material
<b>FIXS-EC PSS</b>	potysk polished	stal nierdzewna stainless steel
<b>FIXS-EC ABS NAS</b>	ciemno szara dark gray	ABS
<b>FIXS-EC ABS NABL</b>	czarna black	ABS
<b>FIXS-EC PVD</b>	imitacja złota similar gold	stal nierdzewna stainless steel



# FIXD

Profil do montażu panelu stałego  
U-section profile for fixed panels

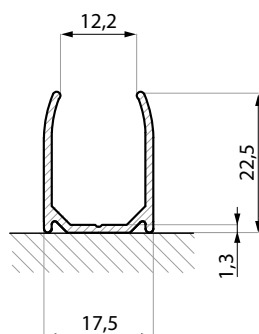

Kod / Code	Wykończenie / Finish
<b>FIXD-2300 PC</b> <b>FIXD-3000 PC</b> <b>FIXD-4000 PC</b>	połysk polished
<b>FIXD-2300 AX</b> <b>FIXD-3000 AX</b>	alinox alinox
<b>FIXD-2300 NABL</b> <b>FIXD-3000 NABL</b>	czarna anoda black anodised
Specyfikacja / Specification	
materiał: material:	aluminium aluminium
grubość szkła (mm): glass thickness (mm):	6-10
długość (mm): length (mm):	połysk / polished finish: 2300; 3000; 4000 alinox / alinox finish: 2300; 3000 czarna anoda / black anodised finish: 2300; 3000

Zaślepka  
End cap

**FIXD-EC**



Kod / Code	Wykończenie / Finish	Materiał / Material
<b>FIXD-EC PSS</b>	połysk polished	stal nierdzewna stainless steel
<b>FIXD-EC SSS</b>	satyna satin	stal nierdzewna stainless steel
<b>FIXD-EC ABS BL</b>	czarna black	ABS

Uszczelka do profilu FIXD  
Seal for FIXD profile

**U**

Dopasowanie uszczelki do grubości szkła  
Assembling of the seals according to the thickness of the glass

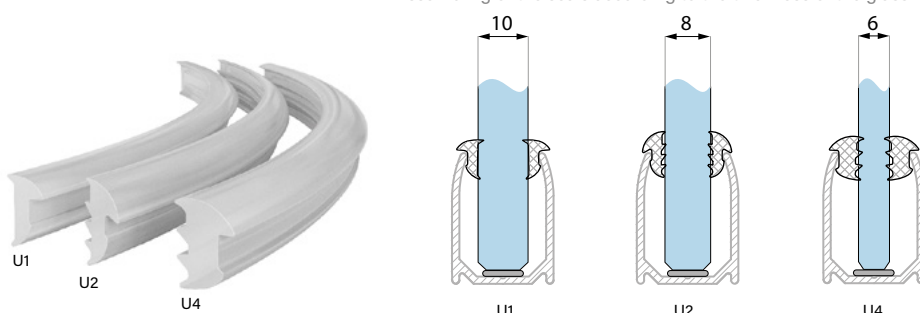

Kod / Code	Wykończenie / Finish
<b>U1</b> <b>U2</b> <b>U4</b>	bezbarna transparent white
<b>U1 BL</b> <b>U2 BL</b> <b>U4 BL</b>	czarna black
Specyfikacja / Specification	
materiał: material:	PVC-S
grubość szkła (mm): glass thickness (mm):	U1=10 / U2=8 / U4=6

## INSTRUKCJA MONTAŻU SZKŁA DO PROFILU FIXD ASSEMBLY INSTRUCTION FOR FIXD PROFILE



## FIXD-COVER

Pokrywa progowa  
Threshold cover profile

Kod / Code	Wykończenie / Finish
<b>FIXD-COV1000 PC</b> <b>FIXD-COV2000 PC</b> <b>FIXD-COV3000 PC</b>	połysk polished
<b>FIXD-COV1000 AX</b> <b>FIXD-COV2000 AX</b> <b>FIXD-COV3000 AX</b>	alinox alinox
<b>FIXD-COV1000 NABL</b> <b>FIXD-COV2000 NABL</b> <b>FIXD-COV3000 NABL</b>	czarna anoda black anodised

### Specyfikacja / Specification

materiał: aluminium  
material: aluminium

pokrywa progowa do widocznego odcinka profilu FIXD bez szkła (w przypadku gdy FIXD użyty jest jako próg)

threshold cover for FIXD profile visible section without glass (in case the FIXD is used as a shower doorstep)

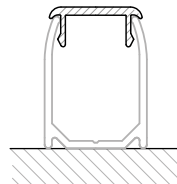
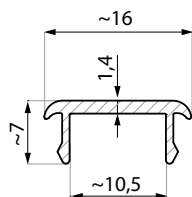

## FCM27U

Profil do montażu panelu stałego  
U-section profile for fixed panels

Kod / Code	Wykończenie / Finish
<b>FCM27U NABL</b>	czarna anoda black anodised
<b>FCM27U PC</b>	połysk polished

### Specyfikacja / Specification

materiał: aluminium  
material: aluminium

grubość szkła (mm):  
glass thickness (mm): 8; 10

długość (mm):  
length (mm): 3000

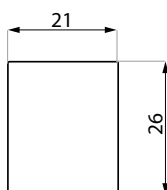
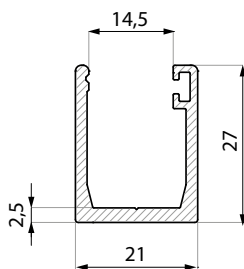

Zaślepka  
End cap

**FCM27U-EC**

Kod / Code	Wykończenie / Finish	Materiał / Material
<b>FCM27U-EC PSS</b>	połysk polished	stal nierdzewna stainless steel
<b>FCM27EC-LH ABS BL</b> <b>FCM27EC-RH ABS BL</b>	czarna black	ABS

## FCM27RS-SET

Zestaw: uszczelka stała UNISEAL + uszczelka klinująca RS-8 / RS-10  
Set: fixed seal UNISEAL + wedge seal RS-8 / RS-10

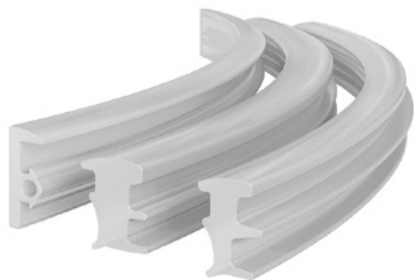

UNISEAL RS-8 RS-10

### Dopasowanie uszczelek do grubości szkła

Assembling of the seals according to the thickness of the glass

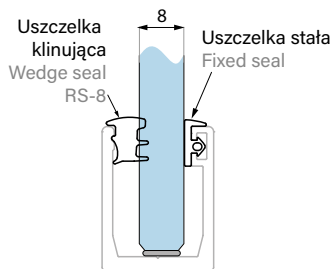

8mm szkło / glass  
RS-8+UNISEAL

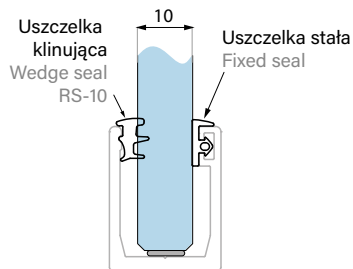

10mm szkło / glass  
RS-10+UNISEAL

Kod / Code	Wykończenie / Finish
<b>FCM27RS-SET08 CLEAR</b>	bezbarwne transparent
<b>FCM27RS-SET08 BL</b>	czarne black
Specyfikacja / Specification	
materiał: material:	PVC-S
grubość szkła (mm): glass thickness (mm):	8
długość (mm): length (mm):	3000 + 3000

Kod / Code	Wykończenie / Finish
<b>FCM27RS-SET10 CLEAR</b>	bezbarwne transparent white
<b>FCM27RS-SET10 BL</b>	czarne black
Specyfikacja / Specification	
materiał: material:	PVC-S
grubość szkła (mm): glass thickness (mm):	10
długość (mm): length (mm):	3000 + 3000

## INSTRUKCJA MONTAŻU SZKŁA DO PROFILU FCM27U

ASSEMBLY INSTRUCTION FOR FCM27U PROFILE

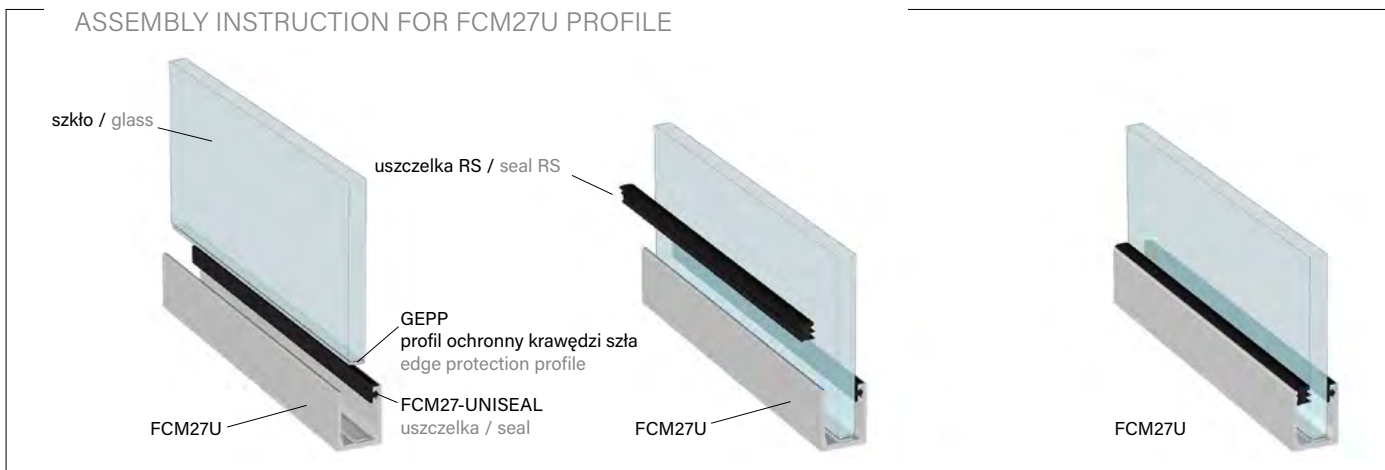

## GEPP

### Profil ochronny na krawędź szkła

Glass edge protection for U-Section profiles

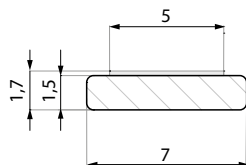

### Specyfikacja / Specification

materiał: material:	tworzywo sztuczne plastic
długość (mm): length (mm):	2300; 3000
zawiera taśmę samoprzylepną with self-adhesive tape	

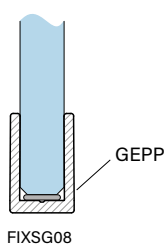

FIXSG08

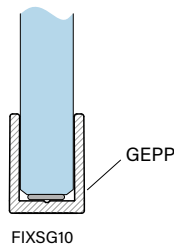

FIXSG10

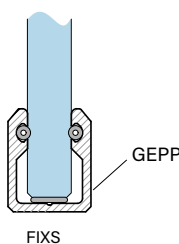

FIXS

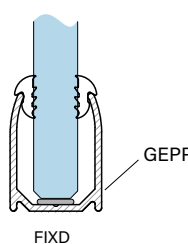

FIXD

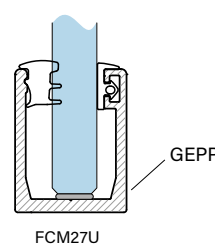

FCM27U

