



SILENZIO

PROFILE ALUMINIOWE DO MONTAŻU ŚCIANEK
O PODWYŻSZONEJ IZOLACYJNOŚCI AKUSTYCZNEJ
ALUMINUM PROFILES FOR MOUNTING WALLS
WITH INCREASED ACOUSTIC INSULATION

CDA

SILENZIO

PROFILE ALUMINIOWE DO MONTAŻU ŚCIANEK O PODWYŻSZONEJ IZOLACYJNOŚCI AKUSTYCZNEJ

ALUMINUM PROFILES FOR MOUNTING WALLS
WITH INCREASED ACOUSTIC INSULATION



Izolacyjność akustyczna systemu SILENZIO CDA Bufab

Acoustic insulation of the SILENZIO CDA Bufab system

Zastosowane szkło	Rw[dB]	C [dB]	RA1 [dB]
VSG 44.2 + VSG 55.2	43	-1	42
VSG 44.2 + VSG 66.2	44	-1	43
VSG 44.2 + VSG 66.2 silence	47	-2	45
VSG 55.2 + VSG 66.2	50	-2	48
VSG 66.2 + VSG 88.2 silence i wkładkami akustycznymi wzdłuż kształtowników ramy	53	-2	51
VSG 66.2 + VSG 88.2 silence i wkładkami akustycznymi wzdłuż kształtowników ramy oraz pionowych połączeń przeszkleń	56	-2	54

Dzięki odpowiednio zaprojektowanym profilom konstrukcyjnym, system pozwala na zastosowanie różnych grubości szkła, co pozwala na obniżenie kosztów inwestycji w przypadku mniejszych wymagań co do izolacyjności akustycznej przegrody.

Thanks to appropriately designed structural profiles, the system allows for the use of different glass thicknesses, which helps reduce investment costs in cases of lower acoustic insulation requirements for the partition.

SIL100-BOT

Profil dolny systemu Silenzio
Bottom profile for Silenzio acoustic system

Kod / Code	Materiał / Material	Wykończenie / Finish
SIL100-BOT-3000AL	aluminium aluminium	surowe aluminium raw aluminium

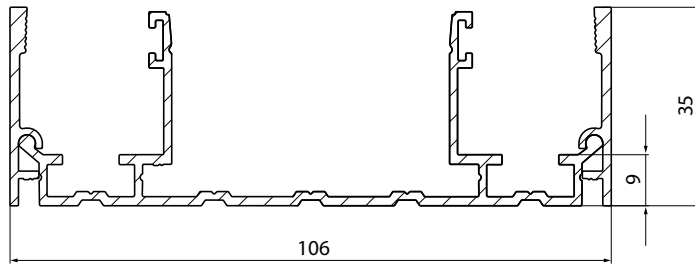
**SIL100-DPP**

Profil górny systemu Silenzio
Top profile for Silenzio acoustic system

Kod / Code	Materiał / Material	Wykończenie / Finish
SIL100-DPP-3000AL	aluminium aluminium	surowe aluminium raw aluminium

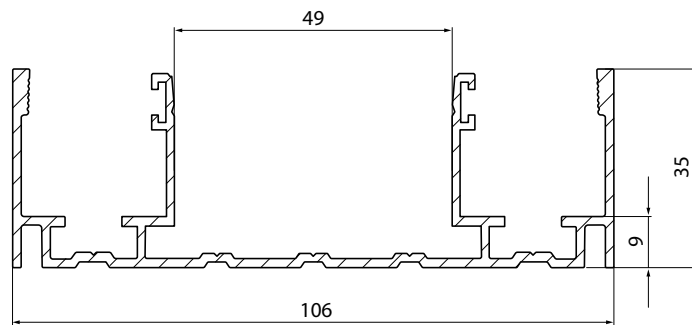
**SIL100-FR**

Profil ościeżnicowy systemu Silenzio
Frame profile for Silenzio acoustic system

Kod / Code	Materiał / Material	Wykończenie / Finish
SIL100-FR-3000AL	aluminium aluminium	surowe aluminium raw aluminium

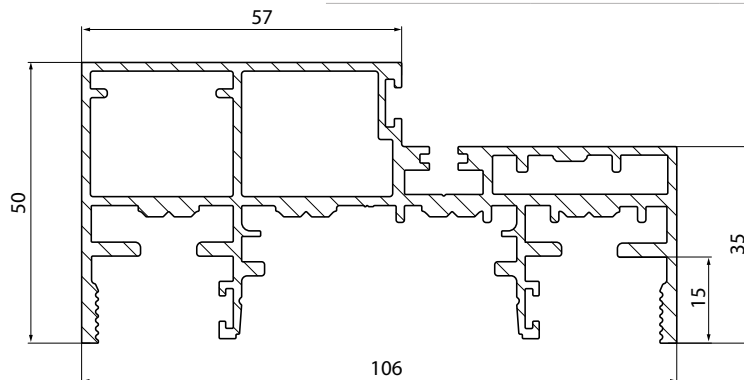
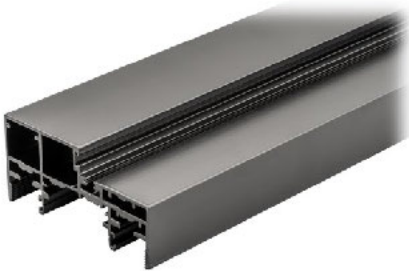
**SIL100-IP COVER**

Maskownica międzyszybowa systemu Silenzio
Interpanel cover for Silenzio acoustic system

Kod / Code	Materiał / Material	Wykończenie / Finish
SIL100-IP COVER	aluminium aluminium	surowe aluminium raw aluminium

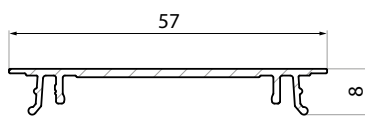

SIL100-DPP

Profil główny skrzydła drzwiowego
Main profile for door panel

Kod / Code	Materiał / Material	Wykończenie / Finish
SIL100-DPP-3000AL	aluminium aluminium	surowe aluminium raw aluminium

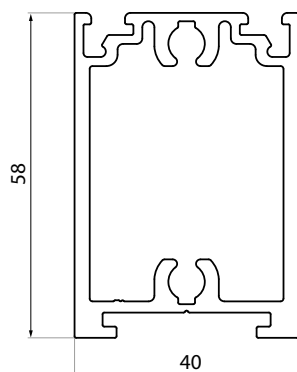

SIL100-DPP13 CLIPS

Klips do profilu SIL100-DPP
dla szkła 13 mm
Clips for SIL100-DPP profile
for 13 mm glass thickness

Kod / Code	Materiał / Material	Wykończenie / Finish
SIL100-DPP13 CLIPS-3000AL	aluminium aluminium	surowe aluminium raw aluminium

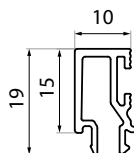

SIL-DPP32 CLIPS

Klips do profilu SIL100-DPP dla szkła
o grubości zespolenia 28 mm i 32 mm
Clips for SIL100-DPP profile for insulated
glass 28mm and 32mm glass unit

Kod / Code	Materiał / Material	Wykończenie / Finish
SIL-DPP32 CLIPS-3000AL	aluminium aluminium	surowe aluminium raw aluminium

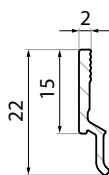

SIL-DPP COVER

Maskownica profilu głównego SIL100-DPP
Cover for main profile SIL100-DPP

Kod / Code	Materiał / Material	Wykończenie / Finish
SIL-DPP COVER-3000AL	aluminium aluminium	surowe aluminium raw aluminium

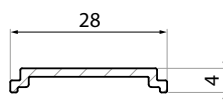

DOBÓR USZCZELEK W ZALEŻNOŚCI OD DOBRANEGO ROZWIĄZANIA

SELECTION OF SOLUTION DEPENDING OF GLASS UNIT

rozwiązanie optymalne
optimal solution

rozwiązanie alternatywne
alternative solution

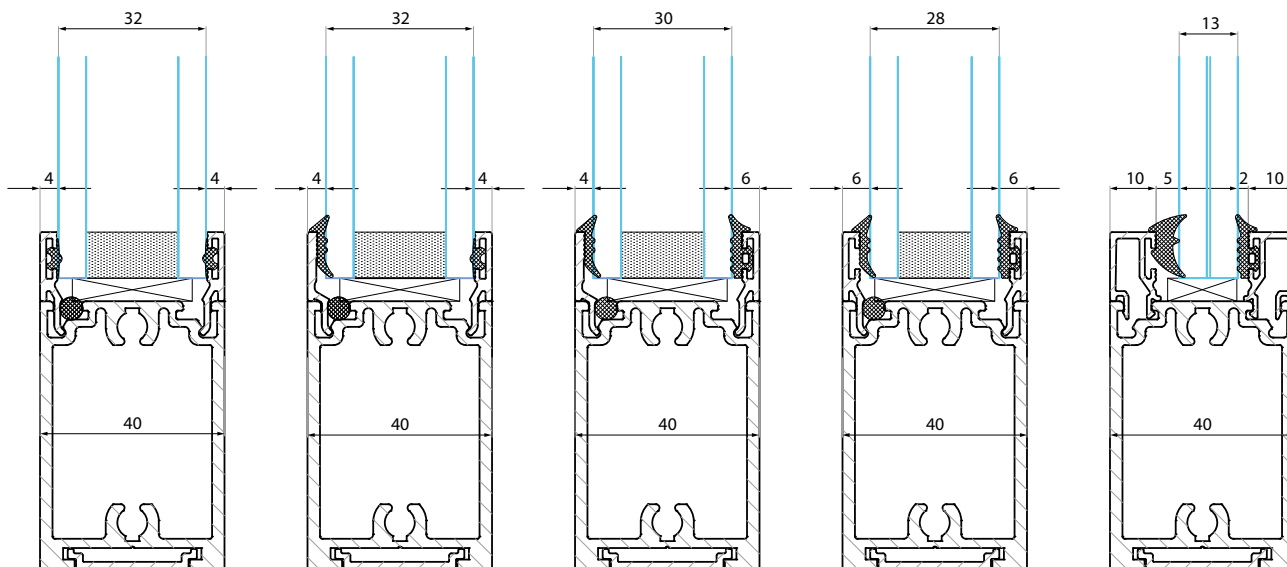

uszczelka/ seal SIL-U2



uszczelka/ seal SIL-U4



uszczelka/ seal SIL-UF2



uszczelka/ seal SIL-FIX



SIL100-SEAL 8

Uszczelka
Seal

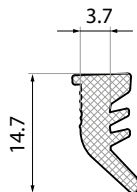

Kod / Code	Materiał / Material	Wykończenie / Finish
SIL100-SEAL 8	EPDM	czarny black

Specyfikacja / Specification

dla szkła 44.2 mm
for glass 44.2 mm

SIL100-SEAL 10

Uszczelka
Seal

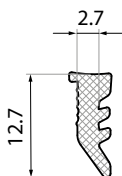

Kod / Code	Materiał / Material	Wykończenie / Finish
SIL100-SEAL 10	EPDM	czarny black

Specyfikacja / Specification

dla szkła 55.2 mm
for glass 55.2 mm

SIL100-SEAL 12

Uszczelka
Seal

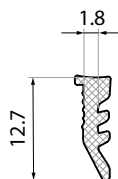

Kod / Code	Materiał / Material	Wykończenie / Finish
SIL100-SEAL 12	EPDM	czarny black

Specyfikacja / Specification

dla szkła 66.2 mm
for glass 66.2 mm

SIL100-SEAL FIX08

Uszczelka stała
Fix seal

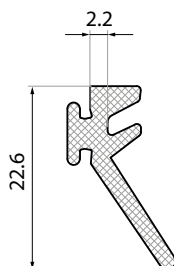

Kod / Code	Materiał / Material	Wykończenie / Finish
SIL100-SEAL FIX08	EPDM	czarny black

Specyfikacja / Specification

dla szkła 44.2 mm
for glass 44.2 mm

dla szkła 55.2 mm
for glass 55.2 mm

SIL100-SEAL FIX10

Uszczelka stała
Fix seal

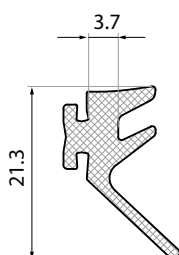

Kod / Code	Materiał / Material	Wykończenie / Finish
SIL100-SEAL FIX10	EPDM	czarny black

Specyfikacja / Specification

dla szkła 66.2 mm
for glass 66.2 mm

SIL-FIXUszczelka stała
Fix seal

Kod / Code	Materiał / Material	Wykończenie / Finish
SIL-FIX	EPDM	czarny black

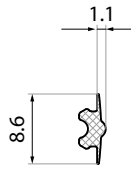
**SIL-FRU06**Uszczelka do profilu ościeżnicowego
Seal for frame profile

Kod / Code	Materiał / Material	Wykończenie / Finish
SIL-FRU06	EPDM	czarny black

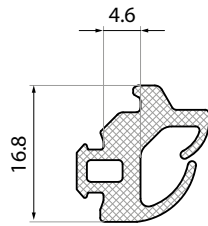
**SIL-BR180**Łącznik 180°
180° connector

Kod / Code	Materiał / Material	Wykończenie / Finish
SIL-BR180	stal nierdzewna stainless steel	surowy raw

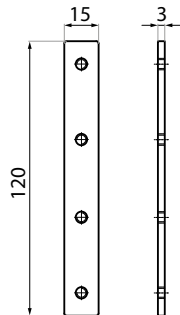
**SIL-BR90**Łącznik 90°
90° connector

Kod / Code	Materiał / Material	Wykończenie / Finish
SIL-BR90	stal nierdzewna stainless steel	surowy raw

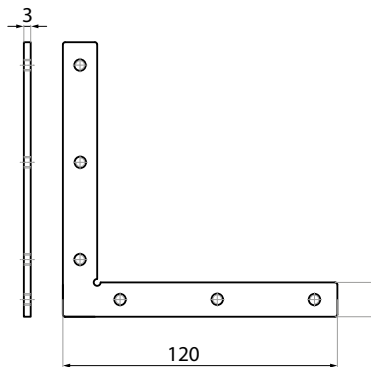

SIL-C

Kątownik montażowy 90°
Corner joint 90°

Kod / Code	Materiał / Material	Wykończenie / Finish
SIL-C	stal nierdzewna stainless steel	surowy raw

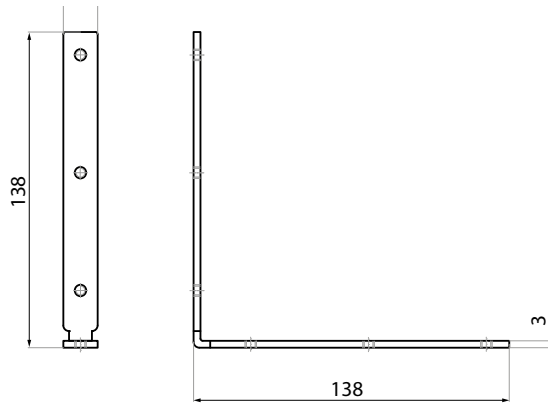

SIL100-LH10

Kłamek z rozetą zamka
Lever handle with the rosettes

Kod / Code	Materiał / Material	Wykończenie / Finish
SIL100-LH SSS	stal nierdzewna stainless steel	satyna satin

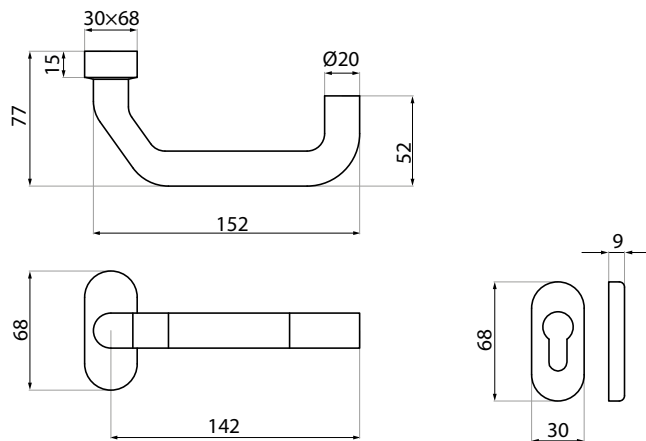

SIL100-LOCK

Zamek wpuszczany drzwi
Mortise lock

Kod / Code	Materiał / Material	Wykończenie / Finish
SIL100LOCK SSS	stal nierdzewna stainless steel	satyna satin

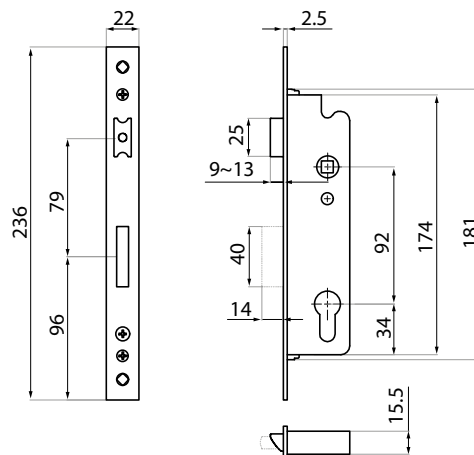

TGLC03

Wkładka
Euro-profile cylinder

Kod / Code	Materiał / Material	Wykończenie / Finish
TGLC03 SC	mosiądz brass	chrom satyna satin chrom

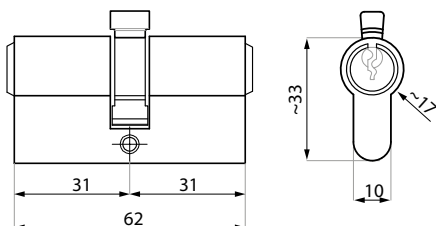

SIL100-PL PLATE

Płytkę zaczepowa zamka
Keeper plate for lock

Kod / Code	Materiał / Material	Wykończenie / Finish
SIL100-PL PLATE SSS	stal nierdzewna stainless steel	satyna satin

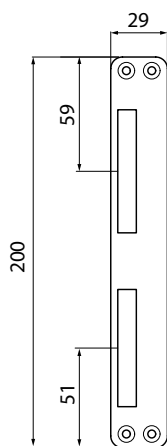

SIL100-FH170

Zawias drzwi systemu Silenzio
Hinge for Silenzio system

Kod / Code	Materiał / Material	Wykończenie / Finish
SIL100-FH170	stal nierdzewna stainless steel	satyna satin

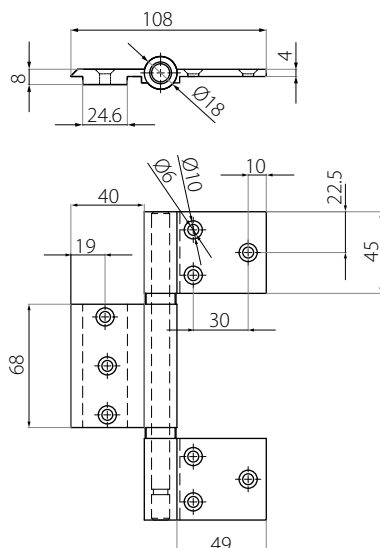

SIL100-ITS90

Listwa międzyszybowa narożna systemu Silenzio
Corner interpanel seal for Silenzio system

Kod / Code	Materiał / Material	Wykończenie / Finish
SIL100-ITS90-9	szkło akrylowe acrylic glass	bezbardwe transparent
SIL100-ITS90-11		
SIL100-ITS90-13		
SIL100-ITS90-17		

Specyfikacja / Specification

długość (mm): 3000
length (mm):

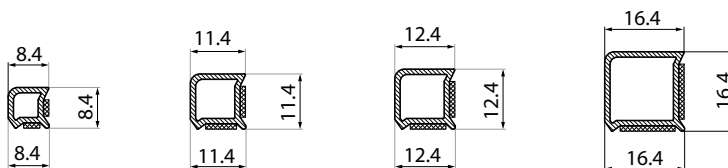

SIL100-CCR 1030

Listwa z uszczelką opadającą do drzwi systemu Silenzio
Drop down seal for Silenzio door panel

Kod / Code	Materiał / Material	Wykończenie / Finish
SIL100-CCR 1030	aluminium aluminium	surowe aluminium raw aluminium

Specyfikacja / Specification

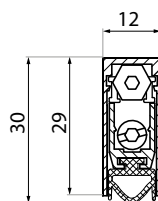

SIL100-ITS180

Listwa międzyszybowa systemu Silenzio
Interpanel seal for Silenzio system

Kod / Code	Materiał / Material	Wykończenie / Finish
SIL100-ITS180 11	szkło akrylowe acrylic glass	bezbardwe transparent
SIL100-ITS180 13		
SIL100-ITS180 18		

Specyfikacja / Specification

długość (mm): 3000
length (mm):

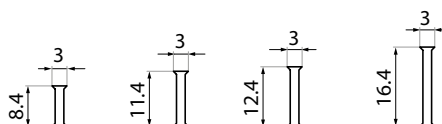

SIL100-U40x33

Profil dolny do montażu listwy SIL100-CCR1030
Bottom installation profile for SIL100-CCR1030

Kod / Code	Materiał / Material	Wykończenie / Finish
SIL100-ITS180	aluminium aluminium	surowe aluminium raw aluminium

Specyfikacja / Specification

długość (mm): 3000
length (mm):

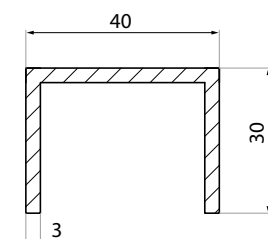
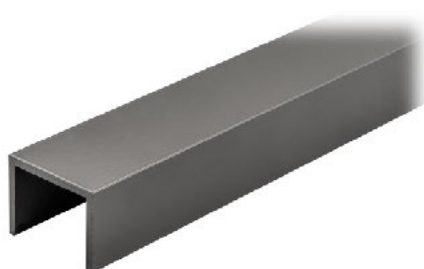

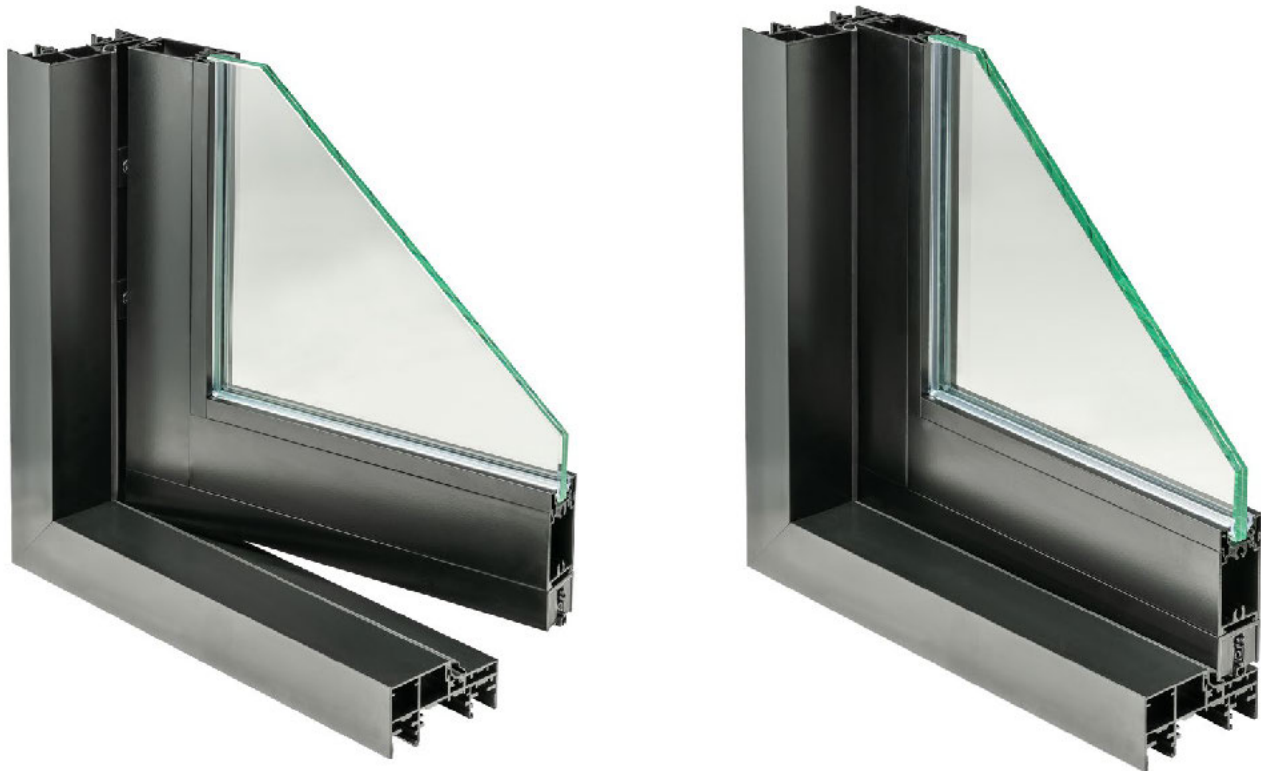

PRZYKŁAD SYSTEMU SILENZIO

DRAFT OF SILENZIO SYSTEM

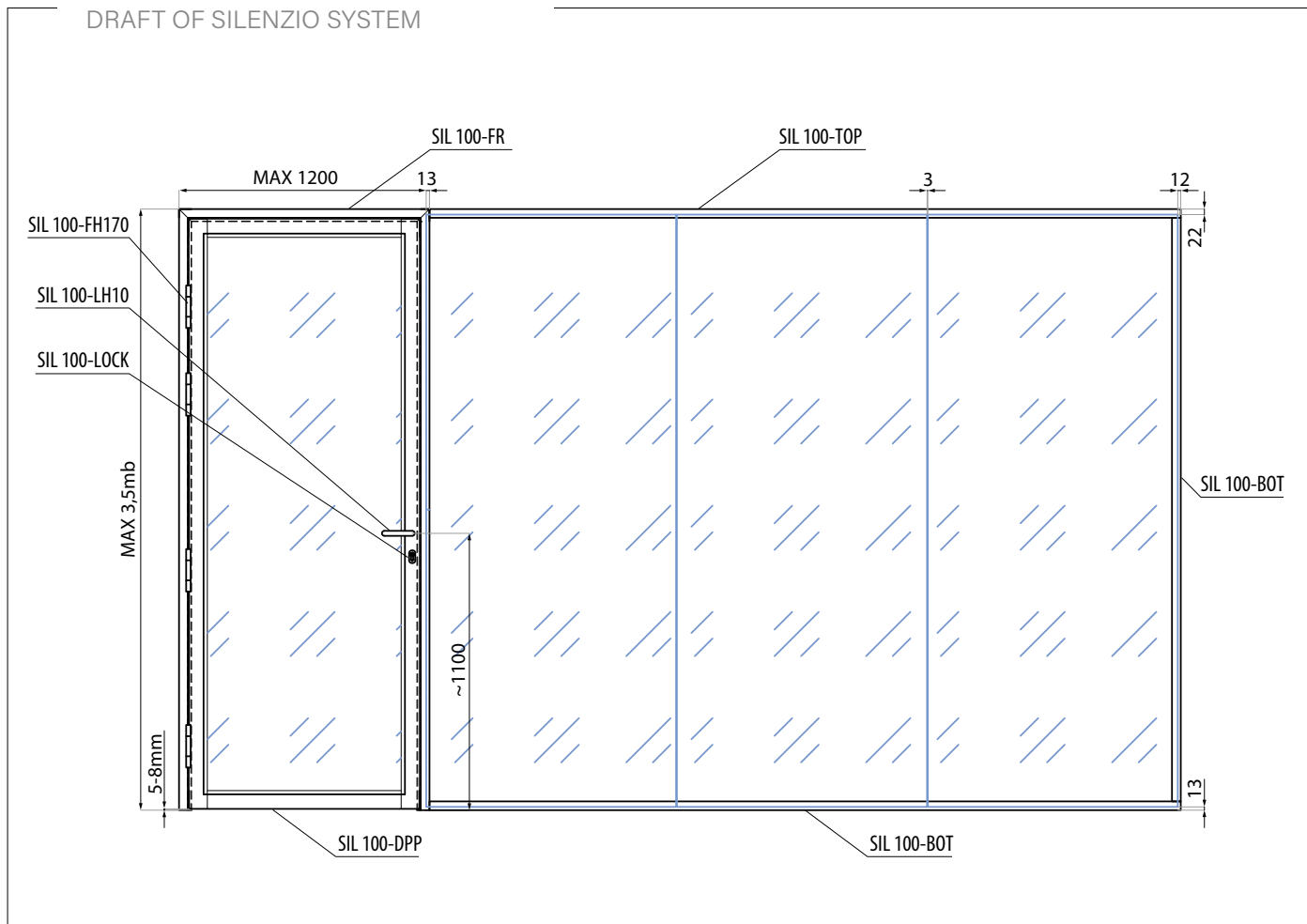

PRZEKRÓJ ŚCIANKI STAŁEJ SYSTEMU SILENZIO ZE SZKŁEM 44.2
CROSS SECTION SILENZIO WALL WITH GLASS 44.2

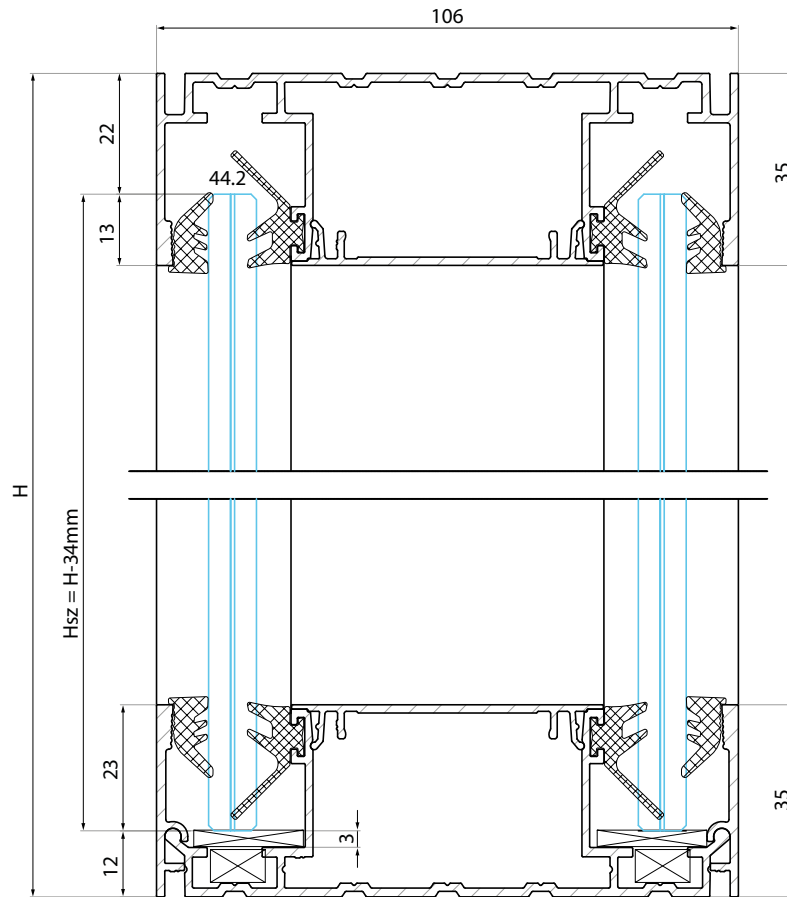

PRZEKRÓJ ŚCIANKI STAŁEJ SYSTEMU SILENZIO ZE SZKŁEM 55.2
CROSS SECTION SILENZIO WALL WITH GLASS 55.2

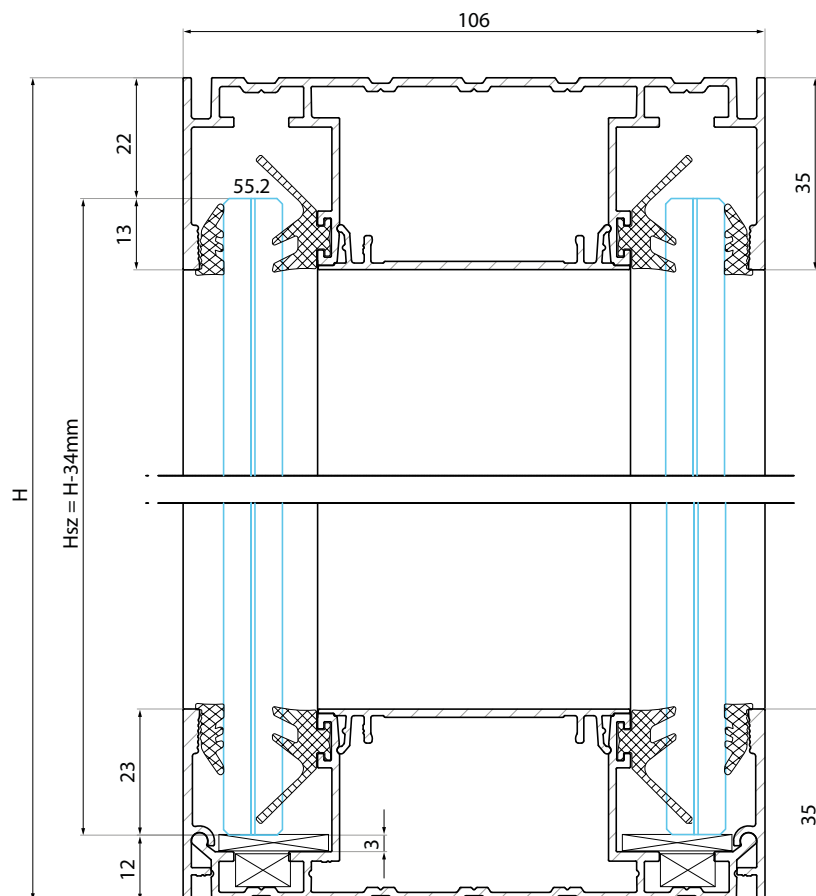

PRZEKRÓJ ŚCIANKI STAŁEJ SYSTEMU SILENZIO ZE SZKŁEM 66.2
CROSS SECTION SILENZIO WALL WITH GLASS 66.2

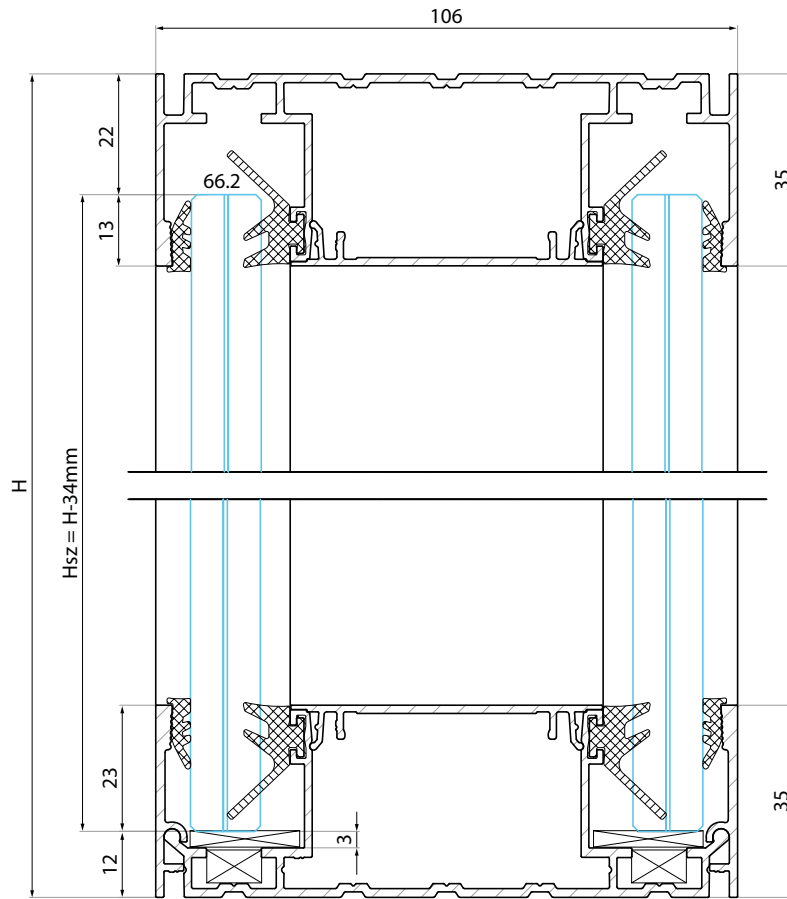

PRZEKRÓJ SYSTEMU SILENZIO - MONTAŻ OŚCIEŻNICY W CIĄGU ŚCIANKI SZKLANEJ
CROSS SECTION SILENZIO SYSTEM - GLASS INSTALLATION OF FRAME PROFILE

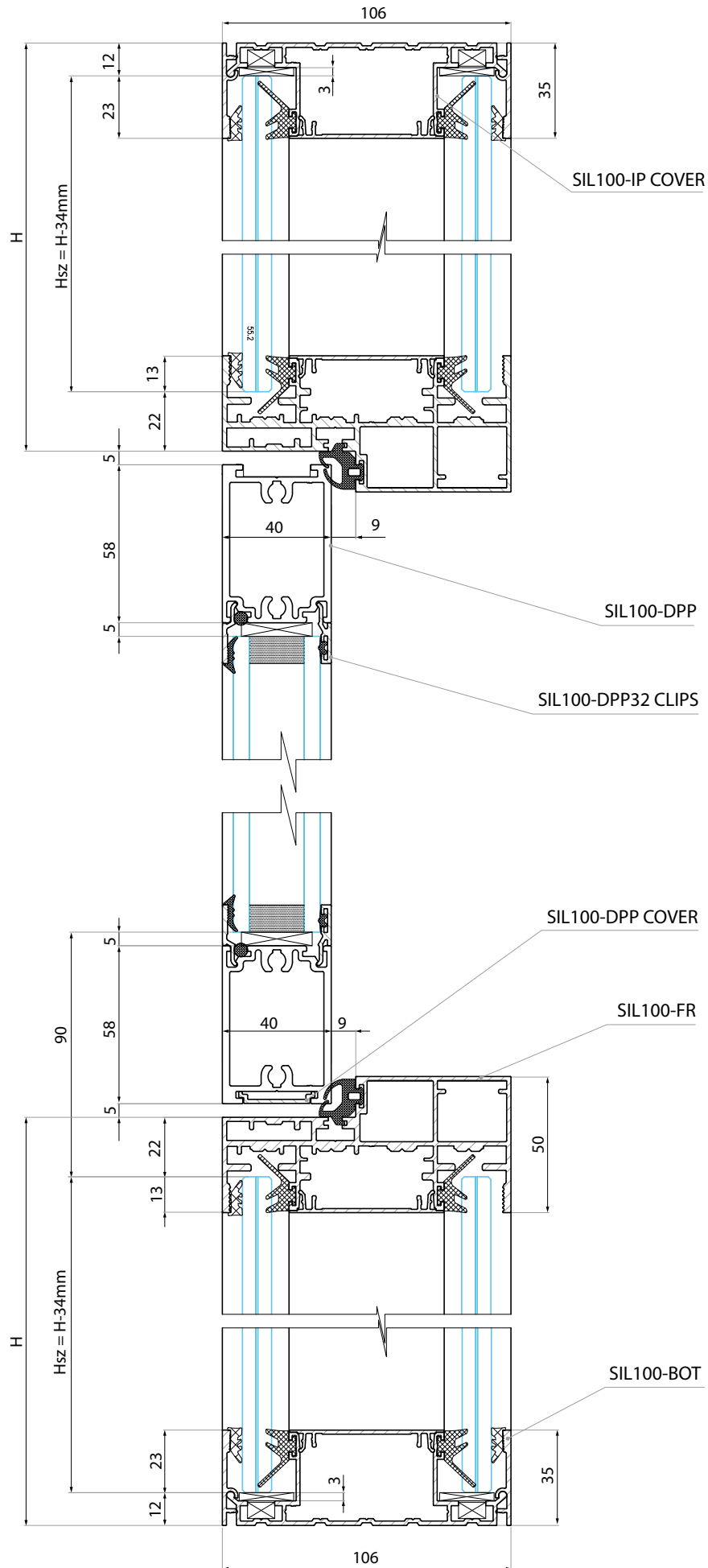

PRZEKRÓJ SYSTEMU SILENZIO - MONTAŻ OŚCIEŻNICY DO ŚCIANY
CROSS SECTION SILENZIO SYSTEM - WALL INSTALLATION OF FRAME PROFILE

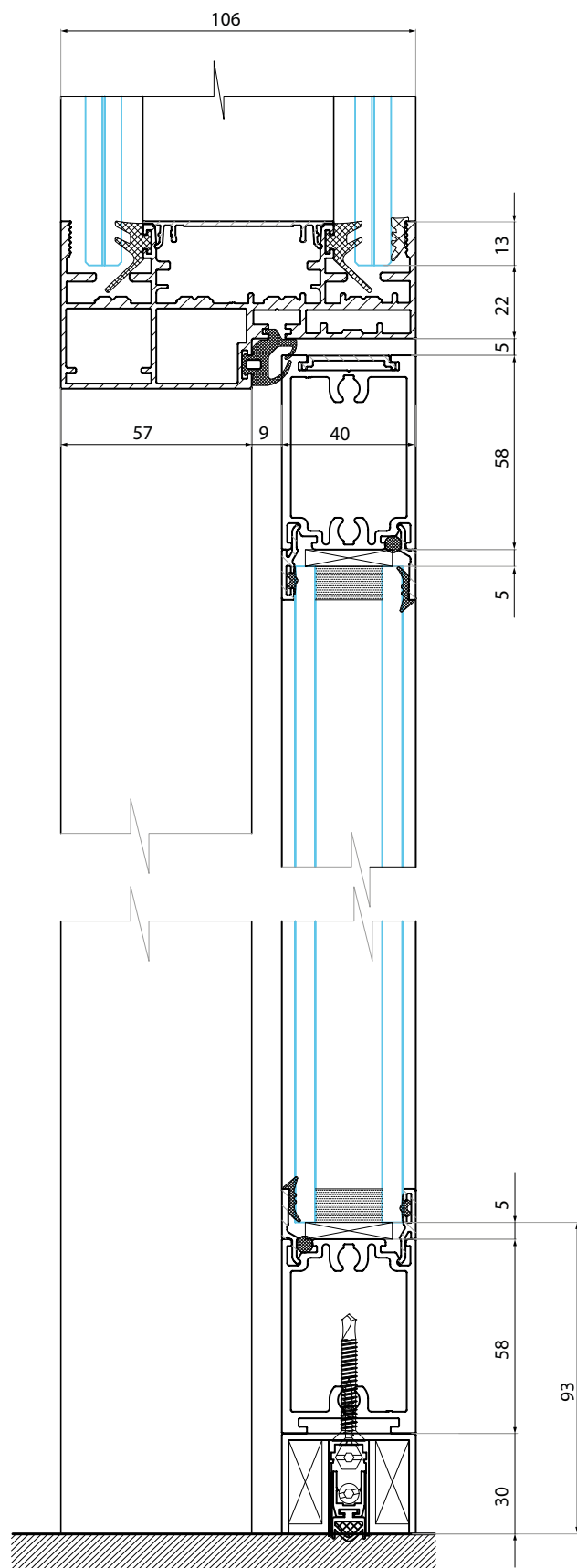

PRZEKRÓJ PIONOWY SYSTEMU SILENZIO ZE SKRZYDŁEM DRZWIOWYM
 VERTICAL CROSS SECTION SILENZIO SYSTEM WITH THE DOOR PANEL

