



MODENA

GAŁKI, UCHWYTY I ZAMKI DO KABIN PRYSZNICOWYCH
KNOBS, PULL HANDLES AND LOCKS FOR THE SHOWER ENCLOSURES

CDA

MODENA

GAŁKI, UCHWYTY I ZAMKI DO KABIN PRYSZNICOWYCH KNOBS, PULL HANDLES AND LOCKS FOR THE SHOWER ENCLOSURES

GAŁKI KNOBS



KHJ15-32



TGKH16-25



KH16-32



KH16-38



KHJ32



KH34-30



KH48JS



KH25-30



KHN30



KHJ24

UCHWYTY
PULL HANDLES



H15-22-220



H19-19-220



H16



H02-20/40-450



H01-KH17-KH01

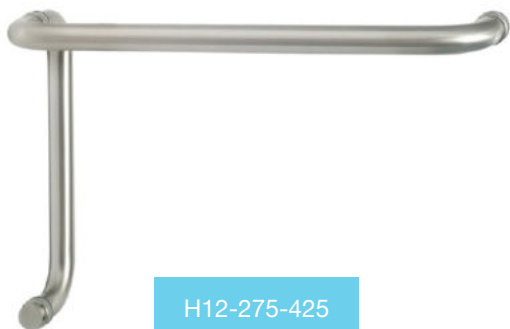

H12-275-425

ZAMEK
LATCH



US625



GK625



KP625

KHJ15-32

Gałka do drzwi Ø32
Door knob Ø32

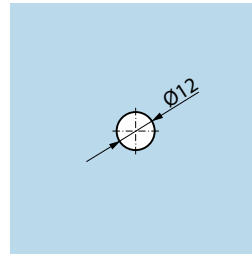
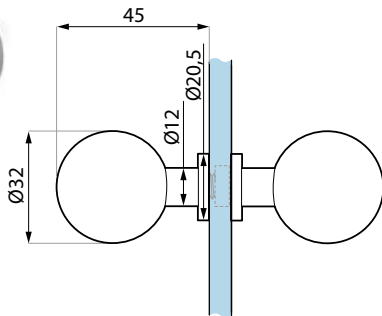

Przygotowanie szkła
Glass preparation

Kod / Code	Wykończenie / Finish
KHJ15-32 PC	chrom polysk polished chrome
KHJ15-32 SC	chrom satyna satin chrome

Specyfikacja / Specification

materiał:	mosiądz
material:	brass
grubość szkła (mm): glass thickness (mm):	8; 10; 12

TGKH16-25

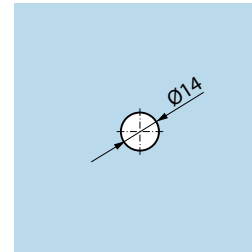
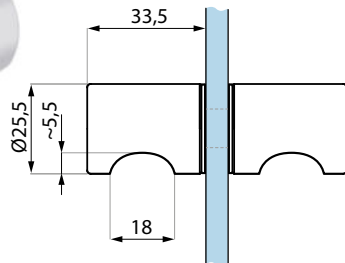

Przygotowanie szkła
Glass preparation

Kod / Code	Wykończenie / Finish
TGKH16-25 PC	chrom polysk polished chrome
TGKH16-25 SC	chrom satyna satin chrome

Specyfikacja / Specification

materiał:	aluminium
material:	aluminium
grubość szkła (mm): glass thickness (mm):	8; 10; 12

KH16-32

Gałka do drzwi Ø32
Door knob Ø32

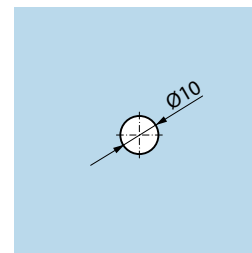
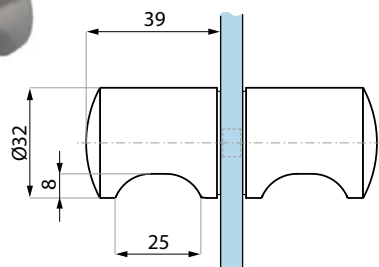

Przygotowanie szkła
Glass preparation

Kod / Code	Wykończenie / Finish
KH16-32 PC	chrom polysk polished chrome
KH16-32 SC	chrom satyna satin chrome

Specyfikacja / Specification

materiał:	mosiądz
material:	brass
grubość szkła (mm): glass thickness (mm):	8; 10; 12

KH16-38

Gałka do drzwi Ø38
Door knob Ø38

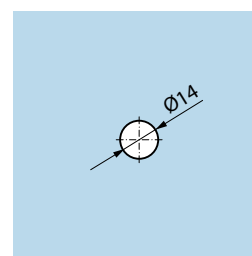
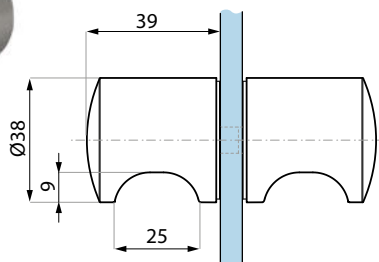

Przygotowanie szkła
Glass preparation

Kod / Code	Wykończenie / Finish
KH16-38 PSS	polysk polished
KH16-38 SSS	satyna satin

Specyfikacja / Specification

materiał:	stal nierdzewna
material:	stainless steel
grubość szkła (mm): glass thickness (mm):	8; 10; 12

KHJ32

Gałka do drzwi Ø32
Door knob Ø32

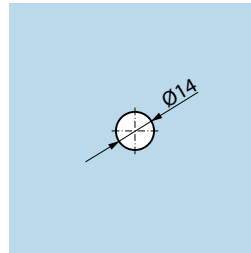
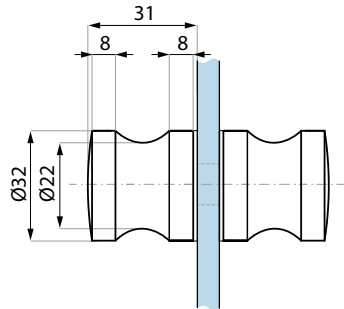

Przygotowanie szkła
Glass preparation

Kod / Code	Wykończenie / Finish
KHJ32 PC	chrom polysk polished chrome
KHJ32 SC	chrom satyna satin chrome
KHJ32 BL	czarna galwanizowana galvanized black

Specyfikacja / Specification	
materiał:	mosiądz
materiał:	brass
grubość szkła (mm):	8; 10; 12
glass thickness (mm):	8; 10; 12

KH34-30

Gałka do drzwi Ø30
Door knob Ø30

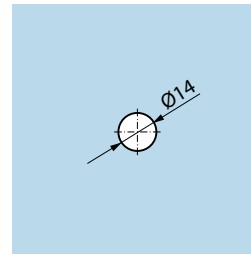
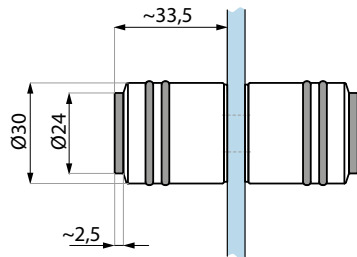

Przygotowanie szkła
Glass preparation

Kod / Code	Wykończenie / Finish
KH34-30 PSS	polysk polished

Specyfikacja / Specification	
materiał:	stal nierdzewna
materiał:	stainless steel
grubość szkła (mm):	6; 8; 10; 12
glass thickness (mm):	6; 8; 10; 12

KH48JS

Gałka jednostronna do drzwi 28x46
Door knob 28x46

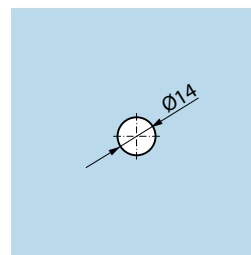
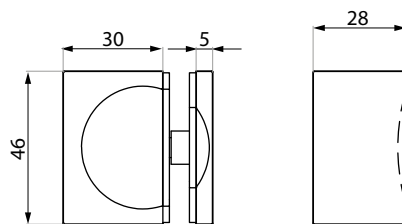

Przygotowanie szkła
Glass preparation

Kod / Code	Wykończenie / Finish
KH48JS PC	chrom polysk polished chrome
KH48JS SC	chrom satyna satin chrome
KH48JS BL	czarna galwanizowana black galvanised

Specyfikacja / Specification	
materiał:	mosiądz
materiał:	brass
grubość szkła (mm):	6; 8; 10
glass thickness (mm):	6; 8; 10

KH25-30

Gałka do drzwi 27x27
Door knob 27x27

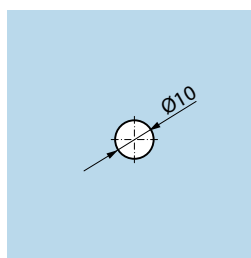
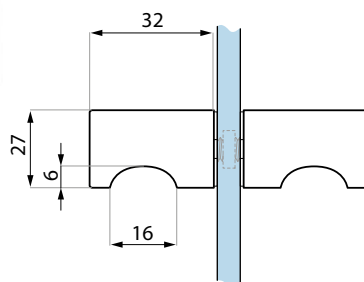

Przygotowanie szkła
Glass preparation

Kod / Code	Wykończenie / Finish
KH25-30 PC	chrom polysk polished chrome
KH25-30 SC	chrom satyna satin chrome
KH25-30 BL	czarna galwanizowana black galvanised

Specyfikacja / Specification	
materiał:	mosiądz
materiał:	brass
grubość szkła (mm):	6; 8; 10; 12
glass thickness (mm):	6; 8; 10; 12

KHN30

Gałka do drzwi 30x30
Door knob 30x30

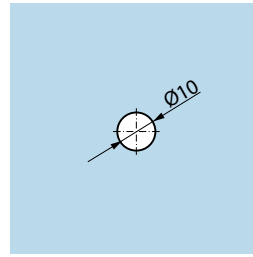
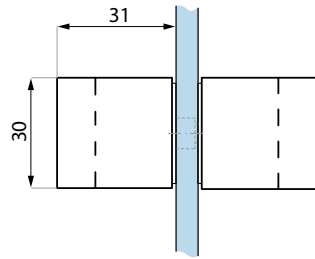
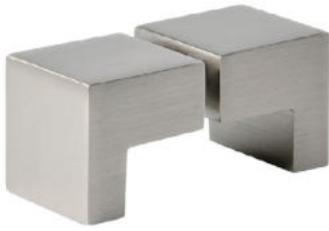

Przygotowanie szkła
Glass preparation

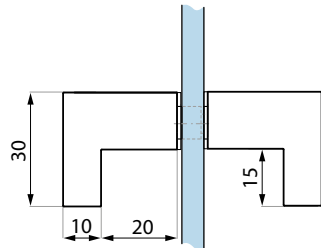

Kod / Code	Wykończenie / Finish
KHN30 PC	chrom połysk polished chrome
KHN30 SC	chrom satyna satin chrome
KHN30 BL	czarna galwanizowana black galvanised

Specyfikacja / Specification

materiał: material:	mosiądz brass
grubość szkła (mm): glass thickness (mm):	8; 10; 12

KHJ24

Gałka do drzwi 35x35
Door knob 35x35

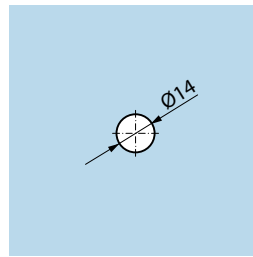
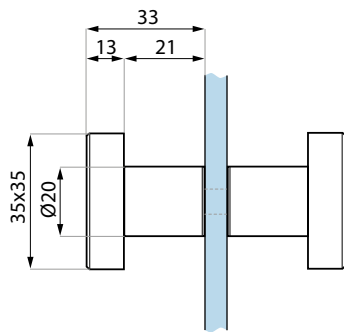

Przygotowanie szkła
Glass preparation



H15-22-220

Uchwyt
Pull handle

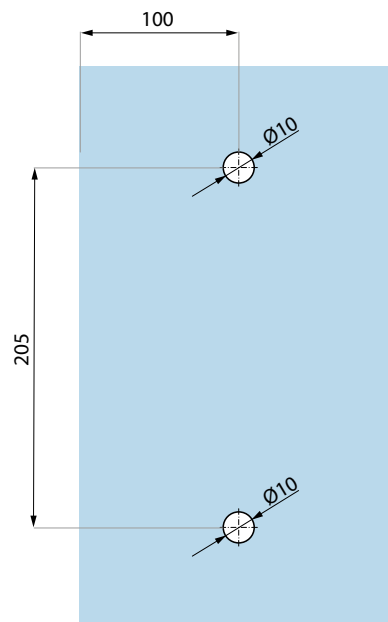
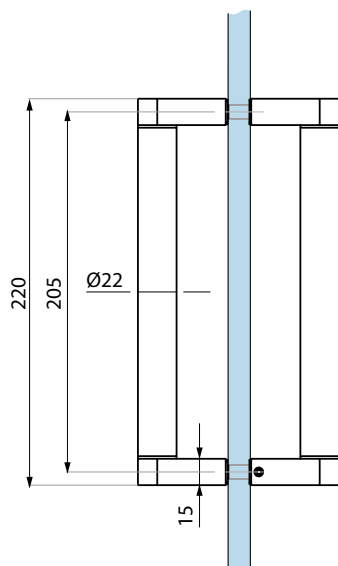

Przygotowanie szkła
Glass preparation

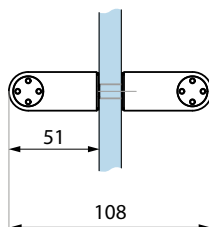

Kod / Code	Wykończenie / Finish
H15-22-220 PSS	połysk polished
Specyfikacja / Specification	
materiał:	stal nierdzewna
materiał:	stainless steel
grubość szkła (mm):	8; 10; 12
glass thickness (mm):	8; 10; 12

H19-19-220

Uchwyt
Pull handle

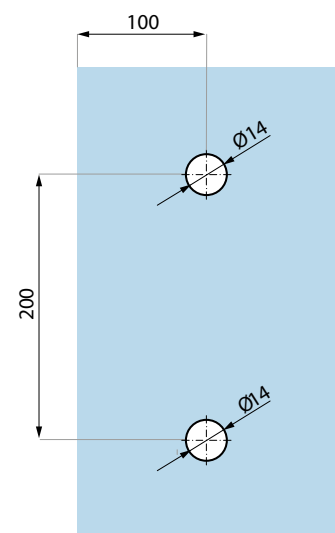
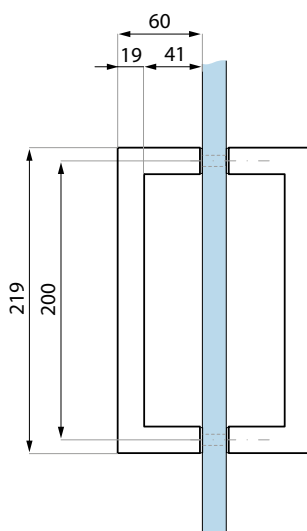

Przygotowanie szkła
Glass preparation

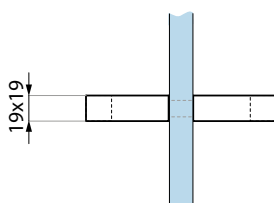

Kod / Code	Wykończenie / Finish
H19-19-220 PSS	połysk polished
H19-19-220 SSS	satyna satin
H19-19-220 BL	czarny black
Specyfikacja / Specification	
materiał:	stal nierdzewna
materiał:	stainless steel
grubość szkła (mm):	8; 10; 12
glass thickness (mm):	8; 10; 12

H16

Uchwyt Pull handle

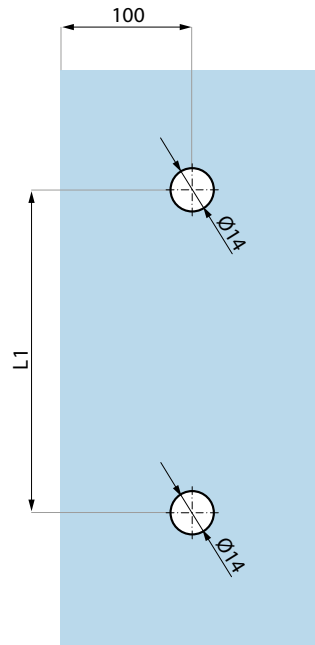
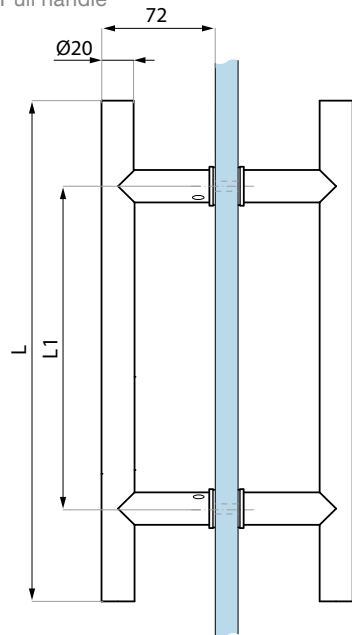

Przygotowanie szkła
Glass preparation

Kod / Code	L	L1	Wykończenie / Finish
H16-20-180L PSS	180	120	polysk
H16-20-300L PSS	300	200	polished
H16-20-180L SSS	180	120	satyna
H16-20-300L SSS	300	200	satın

Specyfikacja / Specification

materiał:	stal nierdzewna
materiał:	stainless steel
grubość szkła (mm):	8; 10; 12
glass thickness (mm):	8; 10; 12

H02-20/40-450

Uchwyt kwadratowy z gałką Square pull handle (towel holder) with knob

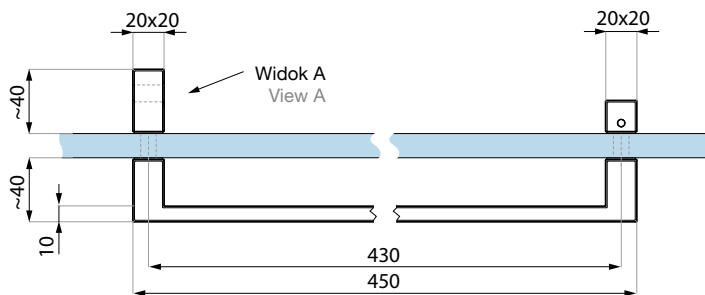

Widok A
View A

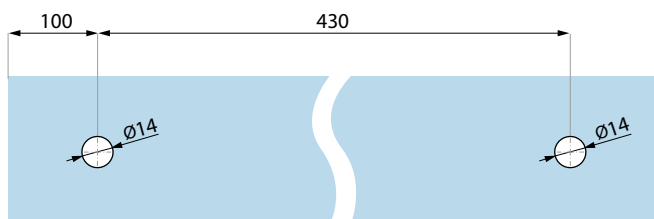
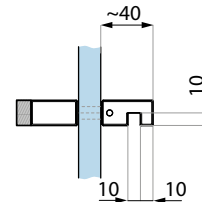

Przygotowanie szkła
Glass preparation

Kod / Code	Wykończenie / Finish
H02-20/40-450 PSS	polysk
	polished
H02-20/40-450 SSS	satyna
	satın
H02-20/40-450 NABL	czarny galwanizowany
	black galvanised

Specyfikacja / Specification

materiał:	stal nierdzewna
materiał:	stainless steel
grubość szkła (mm):	8; 10; 12
glass thickness (mm):	8; 10; 12

H01-KH17-KH01

Uchwyt okrągły z gałką
Round pull handle (towel holder) with knob

Kod / Code	Wykończenie / Finish
H01-KH17-KH01 PSS	połysk polished
H01-KH17-KH01 SSS	satyna satin

Specyfikacja / Specification

materiał:	stal nierdzewna stainless steel
grubość szkła (mm): glass thickness (mm):	8; 10; 12

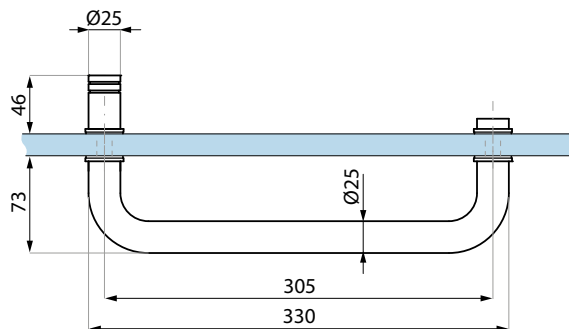

Przygotowanie szkła
Glass preparation

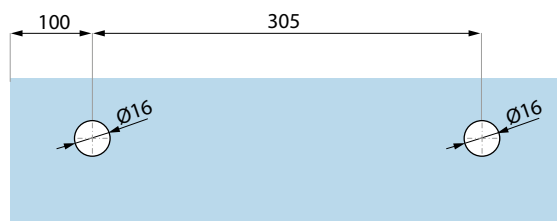

H12-275-425

Uchwyt drzwiowy
Round pull handle (towel holder)

Kod / Code	Wykończenie / Finish
H12-275-425 PSS	połysk polished
H12-275-425 SSS	satyna satin

Specyfikacja / Specification

materiał:	stal nierdzewna stainless steel
grubość szkła (mm): glass thickness (mm):	8; 10; 12

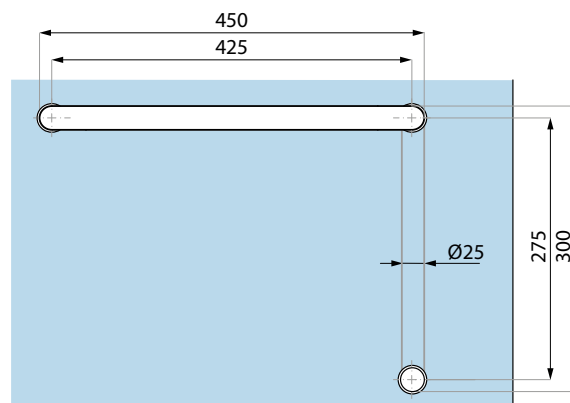
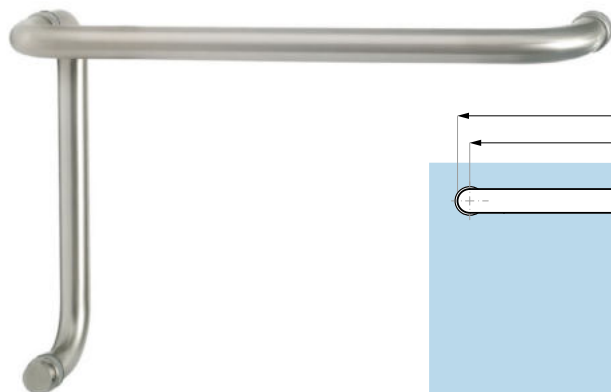

Przygotowanie szkła
Glass preparation

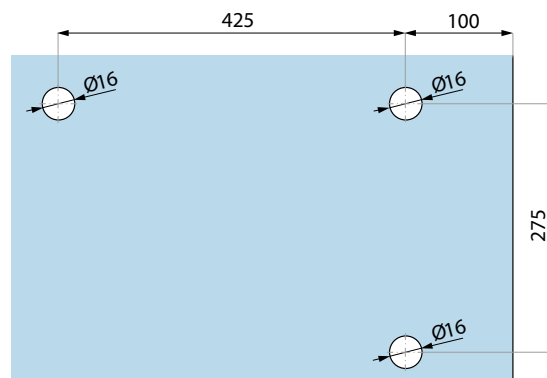

US625

Zamek
Latch

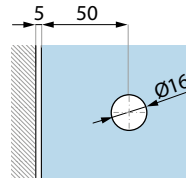
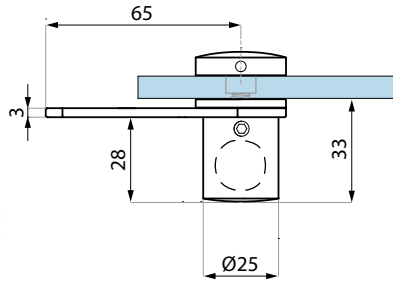

Przygotowanie szkła: mocowane ściana-szkło
Glass preparation: fixing wall to glass

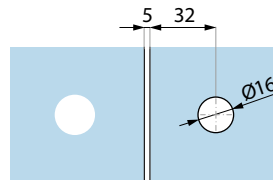

Przygotowanie szkła: mocowanie szkło-szkło
Glass preparation: fixing glass to glass

Kod / Code	Wykończenie / Finish
US625 PSS	połysk polished
US625 SSS	satyna satin

Specyfikacja / Specification	
materiał:	stal nierdzewna stainless steel
grubość szkła (mm): glass thickness (mm):	8; 10; 12

GK625

Zaczep do zamka US625
Strike for latch US625

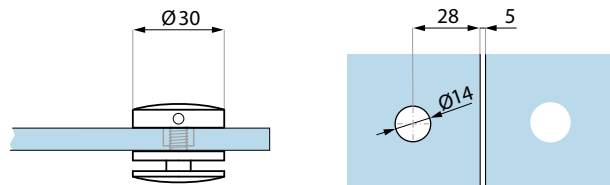

Przygotowanie szkła: mocowanie szkło-szkło
Glass preparation: fixing glass to glass

Kod / Code	Wykończenie / Finish
GK625 PSS	połysk polished
GK625 SSS	satyna satin

Specyfikacja / Specification	
materiał:	stal nierdzewna stainless steel
grubość szkła (mm): glass thickness (mm):	8; 10; 12

KP625

Zaczep do zamka US625 (mocowany na ścianie)
Strike for latch US625 (fixed to wall)

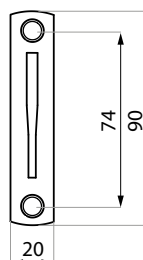

Kod / Code	Wykończenie / Finish
KP625 PSS	połysk polished
KP625 SSS	satyna satin

Specyfikacja / Specification	
materiał:	stal nierdzewna stainless steel